

OPERATING MANUAL



Introduction

According to the sealing performance, pneumatic butterfly valve can be divided into metal seal and soft seal type. Advantages pneumatic butterfly valve over other type valves may include: compact structure, miniature size, long service life, good sealing performance, easy maintenance, quick detachable and installation.

Pneumatic Actuator

Double acting	Air to open, air to close, air supply failure to keep the current position
Single Acting N/C	Air to open, interrupt air to close, air failure to close
Single Acting N/O	Air to close, interrupt air to open, air failure to open
Optional accessory	Reversing solenoid valve, limit switch box, air filter reducing valve, positioner, handle manual, lock up valve



Technical Parameters

Body		Valve components	
Size Range	DN50-DN600	Seating Material	NBR, EPDM, VITON, PTFE
Body material	SS, CI, Ductile Iron, WCB	Disc Material	Stainless Steel
End Connection	Flange	Stem Material	Stainless Steel
Operating Pressure	<1.6MPa	Applicable media	Control of Water, Air, Gas, Oil, Liquid, Steam
Structure	Midline Structure / A-type		

Qutine Size drawing

UNIT: mm

MEDLE	DN50	DN65	DN80	DN100	DN125	DN150	DN200	DN250	DN300	DN350	DN400	DN500
Inch	2"	2-1/2"	3"	4"	5"	6"	8"	10"	12"	14"	16"	20"
D	52.7	64.4	83	104.2	123.3	157	202.5	250.5	301.6	333.3	389.6	491.6
D1	165	185	200	220	250	285	340	395	445	505	565	670
D2	125	145	160	180	210	240	295	355	410	470	525	620
D3	99	118	132	156	184	211	266	319	370	429	480	582
L	108	112	114	127	140	140	150	165	185	195	216	229
H	192	207	224	255	290	325	386	460	510	565	632	759
n-φd	4-φ18	4-φ18	8-φ18	8-φ18	8-φ18	8-φ22	8-φ22	12-φ22	12-φ22	16-φ22	16-φ26	20-φ26

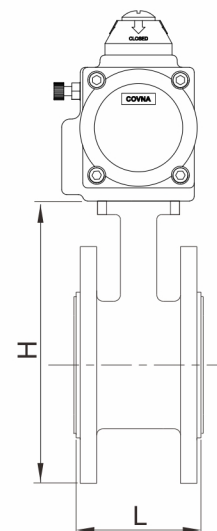

Maintenance

- Tightening the seal between the valve and the actuator:
Remove the four bolts underneath the actuator. Separate the actuator from the valve. Tighten the nut on the top of the valve body. Place the actuator back on the valve and screw everything back into place.
- Tightening the seals between the valve and the inlet/outlet ports:
Remove the torque bolts and check for any debris or damage to the gaskets. Use a torque wrench or other consistent method of tightening the torque bolts to reconnect the inlet and outlet ports.

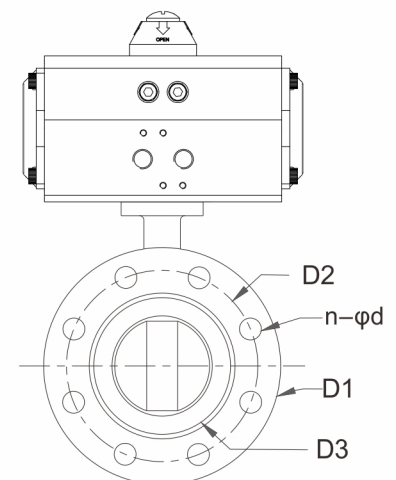

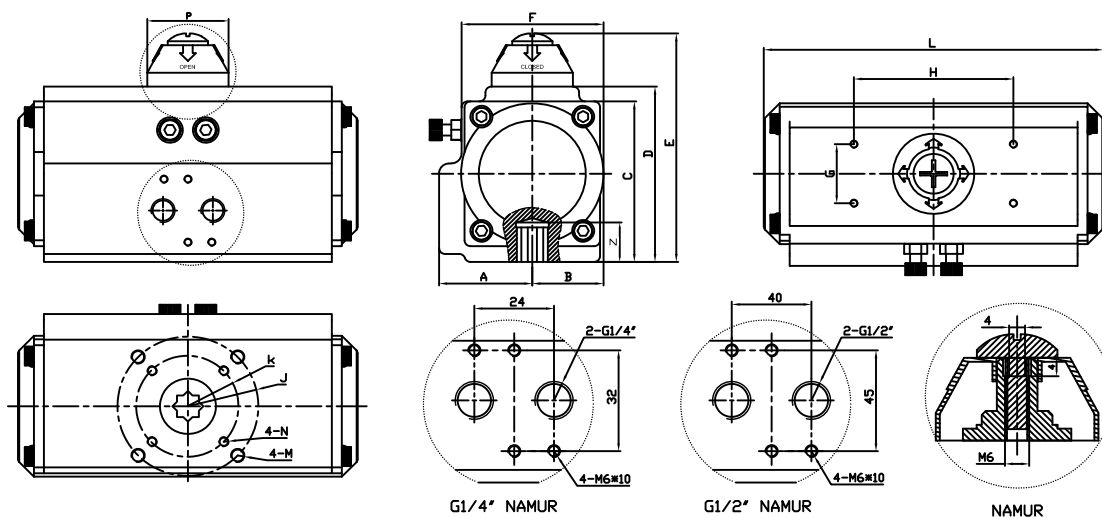

Introduction

1. Operating media: Dry or lubricated air, or the non-corrosive gases The maximum particle diameter must less than 30 u m
2. Air supply pressure: The minimum supply pressure is 2.5 Bar The maximum supply pressure is 8 Bar
3. Operating temperature: Standard: $-20^{\circ} \text{ c} \sim +80^{\circ} \text{ c}$ Low temperature: $-35^{\circ} \text{ c} \sim +80^{\circ} \text{ c}$ High temperature: $-15^{\circ} \text{ c} \sim M50^{\circ} \text{ c}$
4. Travel adjustment: Have adjustment range of $\pm 5^{\circ}$ for the rotation at 0° and 90°

Outline Size drawing

MODEL	A	B	C	D	E	F	G	H	J	K	N	M	L	P	Z	Air Hole
AT52	30	42.5	65.5	72.4	92.5	50.5	30	80	Ø36	Ø50	M5×8	M6×10	150	42	14	NAMUR G1/4"
AT63	36	47	81	88.5	98.5	69.5	30	80	Ø50	Ø70	M6×10	M8×13	171	42	18	NAMUR G1/4"
AT75	42.5	53	93	100	120	78	30	80	Ø50	Ø70	M6×10	M8×13	186	42	18	NAMUR G1/4"
AT83	46.5	57	98.5	109.7	129.5	86	30	80	Ø50	Ø70	M6×10	M8×13	206	42	21	NAMUR G1/4"
AT92	50	58	106	117	137	90	30	80	Ø50	Ø70	M6×10	M8×13	265	42	21	NAMUR G1/4"
AT105	57.5	64	122.5	135	155	104.5	30	80	Ø70	Ø102	M8×13	M10×16	272	42	27	NAMUR G1/4"
At125	67.5	74.5	145.5	157	177	120.5	30	80	Ø70	Ø102	M8×13	M10×16	304	60	27	NAMUR G1/4"
AT140	75.5	75.5	161	174	194	125	30	80	Ø102	Ø125	M10×16	M12×20	395	60	32	NAMUR G1/4"
AT160	87	87	184	198	228	143	30	80	Ø102	Ø125	M10×16	M12×20	462	60	32	NAMUR G1/4"
AT190	103	103	216	232	262	172	30	130	Ø102	Ø140	M10×16	M16×25	520	85	40	NAMUR G1/4"
AT210	113	113	235.5	257	287	194	30	130	Ø102	Ø140	M10×16	M16×25	538	85	40	NAMUR G1/4"
AT240	130	130	235.5	292	322	230	30	130		Ø165		M20×30	592	90	50	NAMUR G1/4"
AT270	147	147	235.5	331	361	253	30	130		Ø165		M20×30	713	90	50	NAMUR G1/2"
AT300	161	168	235.5	354	384	290	30	130	Ø165	Ø215	M20×30	M20×30	771	90	50	NAMUR G1/2"

Common faults and inspection, troubleshooting

Failure Phenomenon	Inspection Items	Solution
Pneumatic Valve Can Not Move	The electromagnetic valve is normal, Coil is burned, electromagnetic valve Is stuck being stolen	Solenoid valve replacement, Replacement coils, remove stolen Property.
	A separate air supply pneumatic Actuator test check seals and Whether the cylinder is damaged.	Replace a bad ring and cylinder.
	There are impurities in the spool Valve stuck.	Remove impurities, replace Damaged parts.
	the handle in a manual hand motor location.	Interchange
Slow Motion, Crawling	Supply pressure is not enough.	The increase of gas supply pressure(0.4–0.7mpa)
	Pneumatic actuator outputtorque is Too small.	Increase the pneumatic actuator Production.
	The valve spool or valve assembly too tight.	Re-assembly adjustments.
	Air supply pipe plug, flow is too small.	Exclude plug, replace the filter cartridge.
Reply Devices Without Signal	power line short circuit or open circuit.	Maintenance of power lines.
	reply within the cam position is not accurate.	Adjust the cam to the correct location
	Micro switch damaged.	Replacement micro switch